

# MS2-110 Positioning Systems

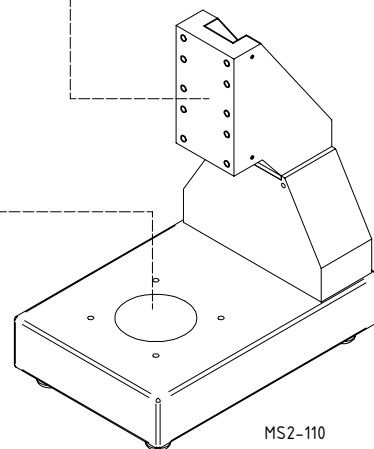
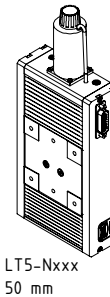
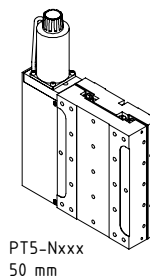
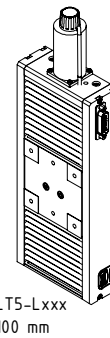
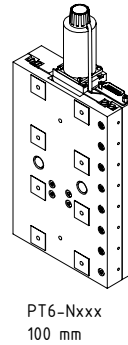
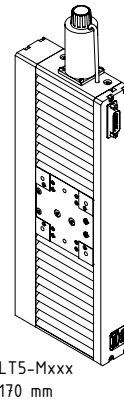
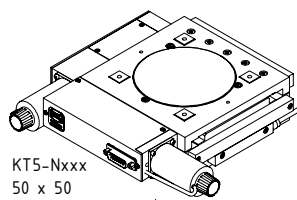
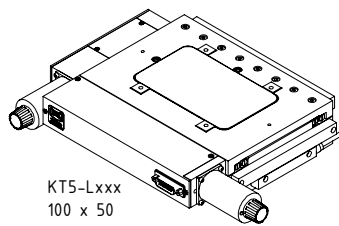
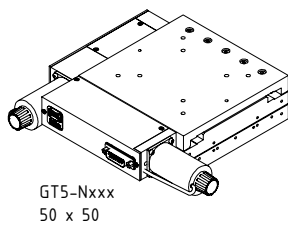
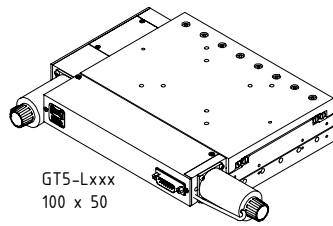

**MS2-110:**  
Stable stand made of granite and massive aluminium suitable for all stages of size 5. Only motorized stages are used as Z-axis.